

Article number: 20343525M8KS
Description: E+G levelling foot
GN 343.5-25-M8-KS

Measures

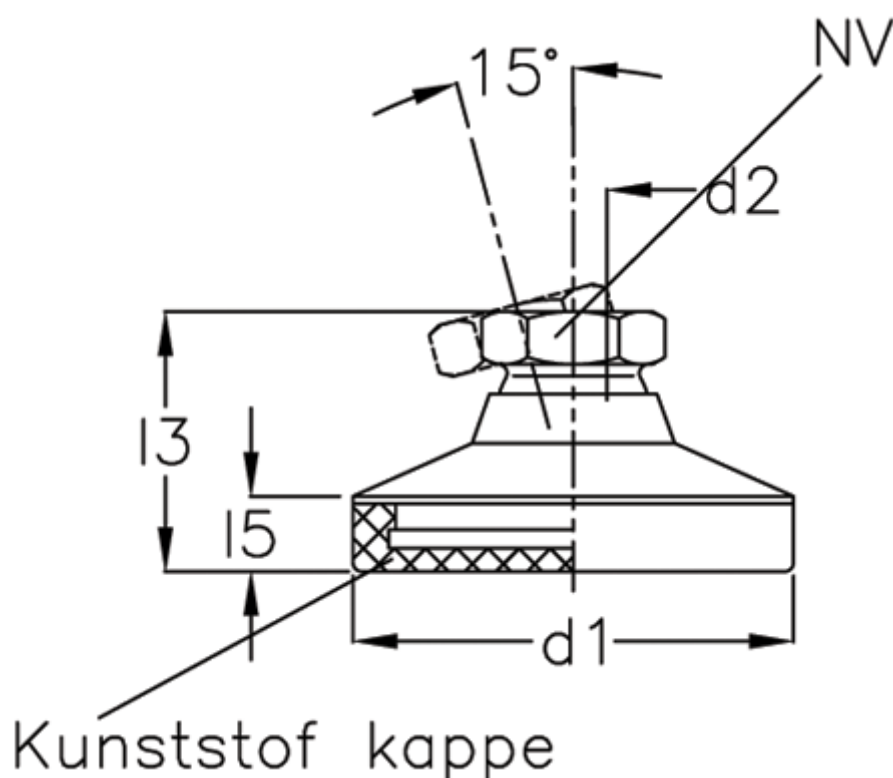

d1	= 25
d2	= 8
l3	= 20.5
l5	= 5.5
NV	= 12
Static load (N)	= 7
t min	= 9